

# *Remote Commander*

---

Operating Instructions

*RM-TP504*

---

## WARNING

To prevent fire or shock hazard, do not expose the unit to rain or moisture.

For the customers in United States

### WARNING

Battery may explode if mistreated, do not recharge, disassemble or dispose of in fire.

When the battery becomes weak or dead, replace the battery with a Sony CR2032 lithium battery, use of any other battery may present a risk of fire or explosion.

Dispose of used battery promptly, keep away from children.

These cells are intended for use at ordinary temperatures where anticipated high temperature excursions are not expected to exceed 100 °C (212 F).

These cells should not be connected in series with electrical power source that would increase the forward current through the cells.

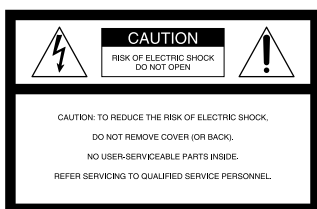

 This symbol is intended to alert the user to the presence of uninsulated “dangerous voltage” within the product’s enclosure that may be of sufficient magnitude to constitute a risk of electric shock to persons.

 This symbol is intended to alert the user to the presence of important operating and maintenance (servicing) instructions in the literature accompanying the appliance.

### INFORMATION

This equipment has been tested and found to comply with the limits for a Class B digital device, pursuant to Part 15 of the FCC Rules.

These limits are designed to provide reasonable protection against harmful interference in a residential installation. This equipment generates, uses, and can radiate radio frequency energy and, if not installed and used in accordance with the instructions, may cause harmful interference to radio communications. However, there is no guarantee that interference will not occur in a particular installation. If this equipment does cause harmful interference to radio or television reception, which can be determined by turning the equipment off and on, the user is encouraged to try to correct the interference by one or more of the following measures:

- Reorient or relocate the receiving antenna.
- Increase the separation between the equipment and control amplifier.
- Connect the equipment into an outlet on a circuit different from that to which the control amplifier is connected.
- Consult the dealer or an experienced radio/TV technician for help.

### CAUTION

You are cautioned that any changes or modification not expressly approved in this manual could void your authority to operate this equipment.

---

## Precautions

For the customers in Europe

### CAUTION (Lithium battery CR2032)

Danger of explosion if battery is incorrectly replaced. Replace only with the same or equivalent type recommended by the manufacturer. Discard used batteries according to the manufacturer’s instructions.

#### On safety

Should any solid object or liquid fall into the cabinet, unplug the receiver and have it checked by qualified personnel before operating it any further.

#### On operation

Before connecting other components, be sure to turn off and unplug the receiver.

#### On cleaning

Clean the cabinet, panel and controls with a soft cloth slightly moistened with a mild detergent solution. Do not use any type of abrasive pad, scouring powder or solvent such as alcohol or benzene.

If you have any question or problem concerning your commander, please consult your nearest Sony dealer.

---

## About This Manual

- The following icon is used in this manual:  
 Indicates hints and tips for making the task easier.

---

## Before You Use the Commander

### Understanding the 2 way remote system

This commander operates under a 2 way remote system. With the 2 way remote system, the component responds to signals sent from the commander by sending additional signals (information about the status of the component, text data, etc.) back to the commander. Thus, operations are performed as a result of communication between the commander and the component.

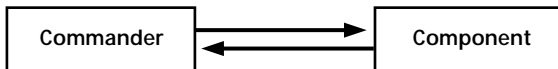

When using a home entertainment system comprised of several components compatible with the 2 way remote system, please restrict 2 way remote system operation to a single component. Generally, the 2 way remote system is turned off on all components except for the receiver. If you would like to turn off the receiver's 2 way remote system, refer to "Setting up the 2 way remote" in the operating instructions supplied with the receiver.

### The COMMAND MODE

If the receiver's COMMAND MODE and the remote's COMMAND MODE do not match, transmission is not possible between the remote and the receiver. If you have not changed the COMMAND MODE of the remote and the receiver after purchase, it is not necessary to set the COMMAND MODE. For details, see page 30.

### Special Remarks

#### ■ About the LCD

Depending on the brightness of the room and the angle at which the commander is viewed, the LCD may be difficult to see. When this occurs, changing the angle of the commander or adjusting the CONTRAST of the LCD may make the LCD easier to see. When fingerprints (etc.) get on the LCD, wipe the LCD with a soft, dry cloth. It is recommended to use the touch pen supplied with the commander.

#### ■ About batteries

##### Life span of the batteries

This commander is different from conventional remotes in that it makes use of a large LCD and is capable of 2 way communication. Because of this, the batteries become exhausted more quickly than with conventional remotes.

Under normal conditions, the batteries should last approximately 2.5 months\*. However, depending on how the remote is used and the initial voltage of the batteries, the actual period of use may be shorter or longer than that mentioned above.

\* This value is based on 60 key operations a day with the backlight on. If the backlight is turned off, the batteries should last much longer. In order to extend the life of the batteries, it is recommended to keep the backlight off when operating the commander in a well lit area.

---

# TABLE OF CONTENTS

---

## Preparations 4

Compatible Components and Functions 4

Preparing the Commander 5

Screen Hierarchy 8

---

## Location of Parts and Basic Operations 9

Front panel 9

Rear panel 10

---

## Operation 11

Basic Operations 11

Example: Operating a CD Player 13

Example: Operating the Tuner 14

Example: Recording from CD to MD 15

Performing Several Commands in Sequence

Automatically (Macro Play) 16

Changing receiver settings 16

Using a command that has been learned 17

Selecting a source to listen to using 2ND ROOM 17

Selecting Sound Fields 18

Adjusting Sound Fields 20

Adjusting the Commander's Operating

Environment 22

---

## Additional information 31

Precautions during use 31

Troubleshooting 32

Specifications 33

Index 33

# Preparations

This chapter describes how to prepare the remote commander for operation. Be sure to read this section before operating.

---

## Compatible Components and Functions

This unit is a remote control system that utilizes infrared rays to control a receiver and AV components connected to the receiver.

### Compatible Components

This unit can be used to operate Sony AV components as well as AV components made by other manufacturers. Setup is necessary in order to operate components made by other manufacturers (see page 23).

#### Note

Depending on the component, control may not be possible using this unit.

### Functions

This unit is a 2 way remote commander. Not only does it transmit infrared rays for operation of the receiver, it also receives infrared rays emitted by the receiver to display characters and other information from components connected to the receiver with a CONTROL A1/A1II cord.

# Preparing the Commander

Please be sure to carry out the procedures described in "Setting up the commander" on page 6 after inserting the batteries.

## Inserting batteries into the commander

Insert the four size-AA (LR6) alkaline batteries (for commander operation) and the lithium battery (for preservation of the commander's internal memory).

### 1 Remove the battery compartment cover.

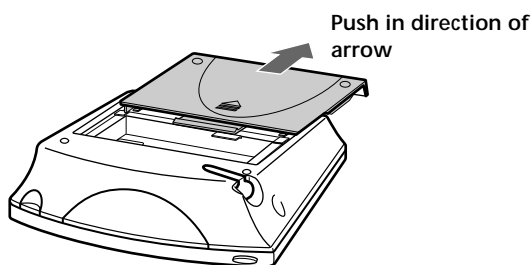

### 2 Insert the alkaline batteries.

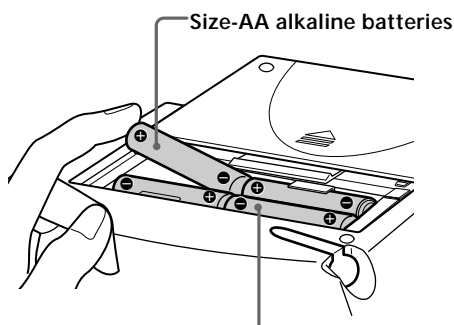

Always insert the negative (-) pole side of batteries first.

### 3 Insert the lithium battery.

After wiping the lithium battery thoroughly with a dry cloth, insert it into the compartment with the positive (+) pole side facing up.

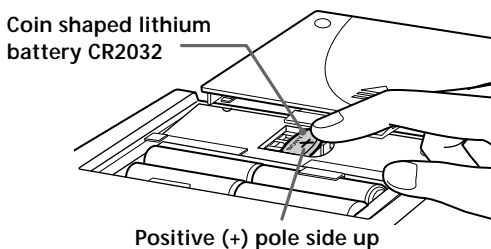

### 4 Close the battery compartment cover.

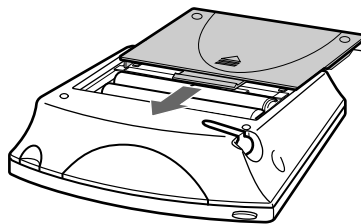

After inserting the batteries, touching the touch panel turns on the light and displays the touch panel (LCD) adjustment screen. Follow the procedure on the next page for touch panel adjustment and initial communication.

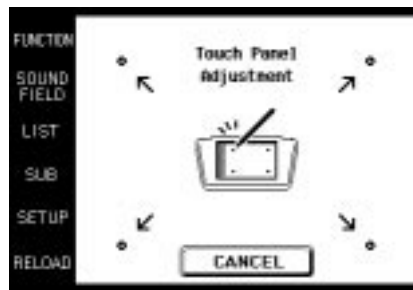

 You can also use an AC power adapter (not supplied) instead of the four alkaline batteries. Connect an AC power adapter (DC 300 mA minimum, 6V) (not supplied) to the DC input jack on the remote commander (see [7](#) on page 10).

#### Polarity of the plug



#### Note!

Be sure to insert the plug of the AC power adapter fully into the DC input jack.

If the plug of the AC power adapter is fully inserted, there may be no problem when you also use batteries. However, if the plug is not fully inserted and the batteries are also used, it may cause a malfunction depending on the adapter (or depending on the plug if the tip is not insulated).

When you are going to use the AC power adapter only for a long time, it is recommended to remove alkaline batteries.

We recommend the use of Sony AC-E60HG (AC power adapter).

#### Notes

- The LCD lights up when touched. The LCD also lights up when BACK LIGHT/COMMANDER OFF button is pressed.
- VOL +/-, MUTING and SLEEP can be used even when the LCD is not lit.
- Pressing BACK LIGHT/COMMANDER OFF turns the backlight on or off. Holding it down for about 2 seconds turns the LCD off.
- If the commander is not used for 10 seconds, the LCD turns off automatically (Auto Off function). The Auto Off function can be changed between 10 and 30 seconds under "Setting the LCD to turn off automatically" in the SETUP screen (see page 29).

## Preparing the Commander

### Setting up the commander

Please be sure to carry out the following 5 steps for preparation of the commander.  
The commander's panel is touch sensitive and can be operated by simply touching it.

#### 1 Remove the touch pen.

When returning the touch pen, always slide it in tip first.

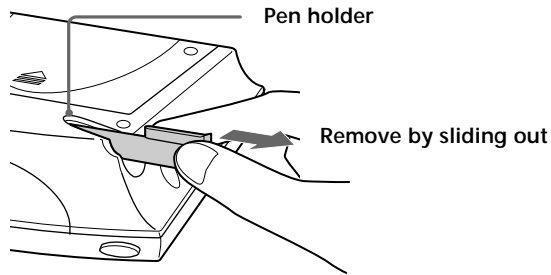

#### Caution

Use only the touch pen provided with this unit or the soft tip of your finger to operate the touch panel. Using a commercially available writing utensil may damage the panel and make correct operation impossible. If the tip of the touch pen is damaged, or the touch pen is lost, please consult your nearest Sony dealer.

#### 2 Turn CONTRAST to adjust brightness of the LCD.

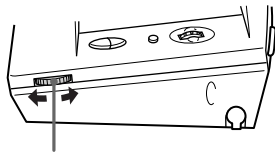

CONTRAST control

### Touch panel adjustment

#### 3 Adjust the position of the touch panel's LCD.

Touch the center of each of the 4 dots with the touch pen. When all 4 dots have been touched "Adjusted" appears, a buzzer sounds, and the initial communication screen appears.

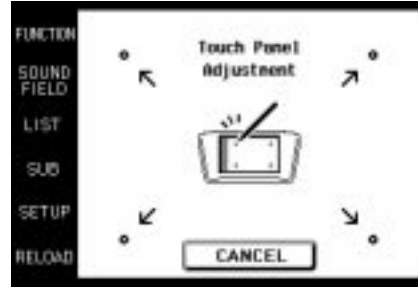

Touch the 4 dots with the touch pen.

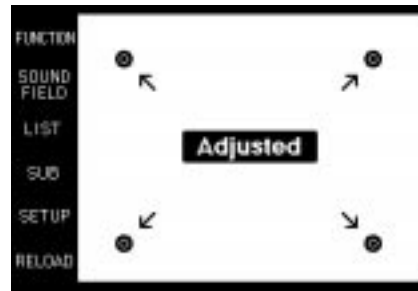

#### Caution

Touch panel adjustment must be carried out for proper panel operation. If used without adjustment, the "Touch Panel Adjustment" screen appears each time the LCD lights up.

### Initial communication

#### 4 Press I/⏻ on the receiver to turn on the receiver.

#### 5 Point the commander's transmitter/receiver section toward the receiver's display, and touch OK.

Once initial communication with the receiver has been established, the commander is ready to operate the receiver.



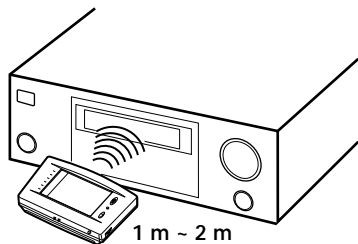

#### Notes

- To ensure good communication conditions, carry out initial setup from directly in front of, and close to the receiver.
- Do not move the unit during initial setup.

#### If a communication error occurs during setup

An error message will be displayed.

- Touching OK will return to the step 5 setup screen.
- Touching SKIP goes to the regular screen without carrying out initial setup. Although operation is possible in this condition, functions not included on the receiver will be displayed, and some buttons will not be operable. Also, the initial setup screen will appear each time the touch panel is turned on.

#### Note

The commander receives and displays data transmitted from the receiver. Communication errors may occur if the commander's transmitter/receiver section is not directed properly toward the receiver's display.

Be sure to point the commander's transmitter/receiver section towards the receiver's display.

### When replacing the batteries

To ensure preservation of the commander's internal memory when replacing batteries, be sure to observe the following cautions.

#### When to replace batteries

When the batteries become weak, a warning sounds and a message is displayed. Replace batteries as instructed by the message.

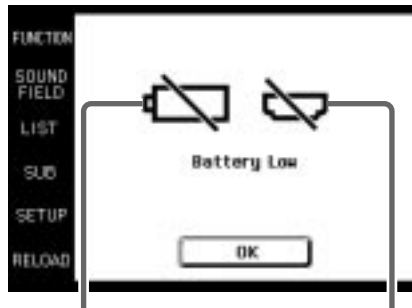

Replace alkaline batteries.

Replace lithium battery.

#### How to remove the lithium battery

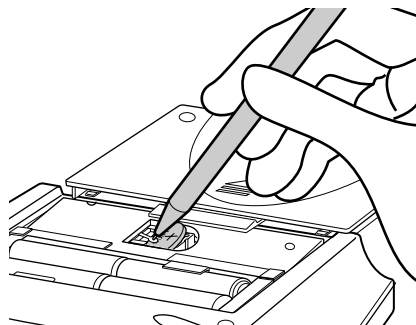

#### Notes

- Disc titles and song titles downloaded from the CD changer are memorized in the commander. The lithium battery is used for preservation of this memory. If the unit is used with an exhausted battery, the settings memorized in the commander will be erased. Please replace the battery as soon as the "Battery Low" message appears.
- Replace the alkaline batteries with new batteries as soon as their charge is exhausted. If the unit is used with exhausted batteries, exhaustion of the lithium battery used to maintain memory will be quickened and the memorized settings may be erased.
- The life span of batteries may be shortened depending on the conditions in which the commander is used.
- If the alkaline batteries and lithium battery become exhausted at the same time, replace the alkaline batteries first. Replacing the lithium battery first will erase the data memorized in the commander.
- When replacing the alkaline batteries, always replace all 4 batteries with new ones.
- After replacing batteries, be sure to carry out touch panel adjustment (page 6).

# Screen Hierarchy

The following diagram shows the basic composition of this unit's screen hierarchy.

**FUNCTION screen** Normally, the FUNCTION screen is displayed. You can use the JOG DIAL to scroll. To display a different screen, touch the left side of the LCD.

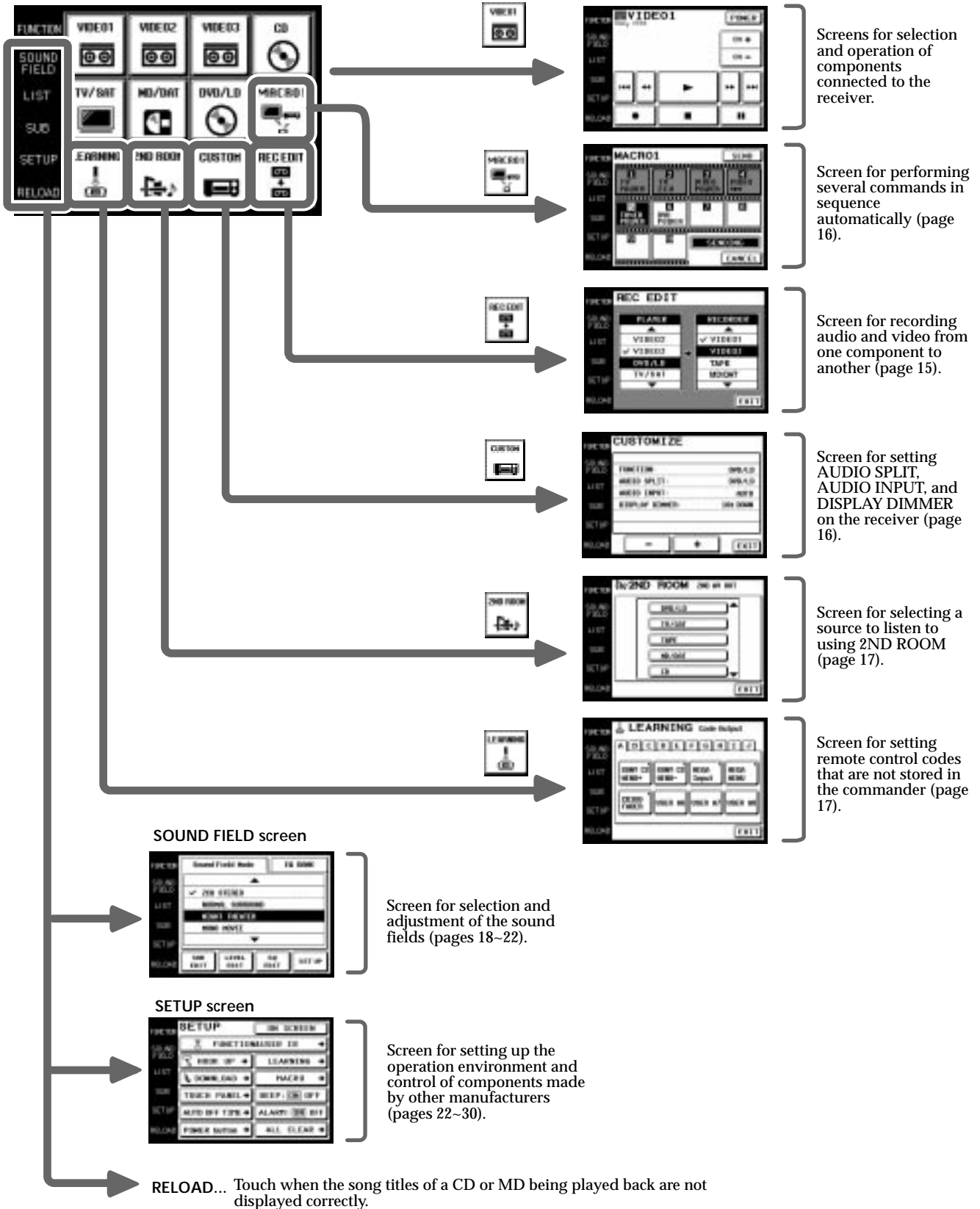



# Location of Parts and Basic Operations

This chapter provides information about the locations and functions of the buttons and controls on this unit. However, some functions in this section may not operate depending on the receiver.

## Front panel

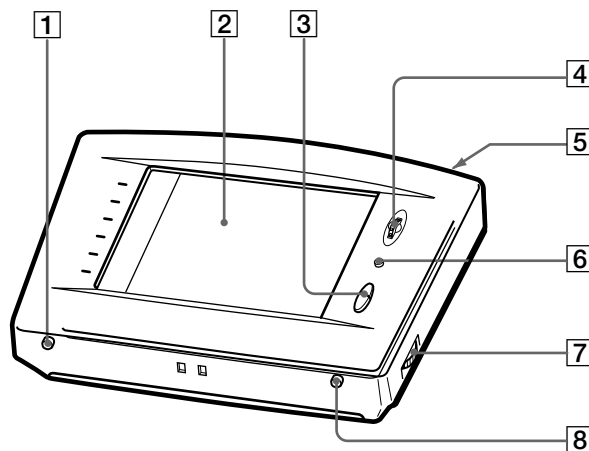

- 1 BACK LIGHT/COMMANDER OFF**

Press to turn the backlight on or off. Hold down for about 2 seconds to turn the LCD off. When the LCD is off, press to turn on the LCD and backlight.

  - To prolong use of the batteries, the LCD automatically turns off if there are no commands entered in the touch panel for 10 seconds.
  - To view the LCD display without turning on the backlight, touch the touch panel when both the backlight and LCD are off.
- 2 Touch panel**

Touch to operate. The commander turns on automatically.
- 3 VOL +/- buttons**

Use to adjust the volume of the receiver.
- 4 JOG DIAL control**

Rotate to scroll through items in a list (etc.).  
Push to select the highlighted item.
- 5 I/⏻/SYSTEM STANDBY button**

Normally used to turn the receiver on or off. Can also be used to turn off all Sony components (SYSTEM STANDBY) when this button is set to SYSTEM STANDBY in the SETUP screen (see page 29).  
Regardless of the setting, when pressed for more than 3 seconds, the SYSTEM STANDBY code is transmitted only once.
- 6 MUTING button**

Use to mute the sound of the receiver.
- 7 CONTRAST control**

Use to adjust the contrast of the LCD.
- 8 SLEEP button**

Use to operate the receiver's sleep function. The sleep settings appear in the receiver's display, not the commander's LCD.

## Rear panel

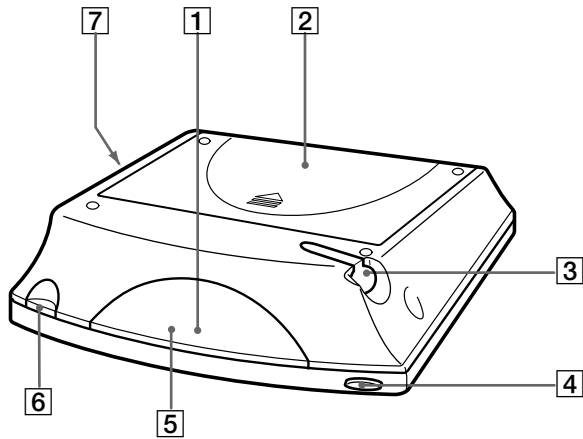

- 1 Transmitter/receiver section**  
Transmits and receives infrared signals to and from the receiver.
- 2 Battery cover**
- 3 Touch pen**
- 4 I/O/SYSTEM STANDBY button**  
Normally used to turn the receiver on or off. Can also be used to turn off all Sony components (SYSTEM STANDBY) when this button is set to SYSTEM STANDBY in the SETUP screen (see page 29).  
Regardless of the setting, when pressed for more than 3 seconds, the SYSTEM STANDBY code is transmitted only once.
- 5 Remote code receiver section**  
When using the Learning function, this section receives the remote codes from other remote controls.
- 6 Touch pen holder**  
Pull out and insert touch pen when not in use.
- 7 DC input jack**  
You can connect an AC power adapter (DC 300 mA minimum, 6V) (not supplied).

# Operation

This chapter explains how to operate the receiver and connected audio/video components.

## Basic Operations

### Displaying the FUNCTION screen

To operate components connected to the receiver, first display the FUNCTION screen, then select the component you wish to operate (CD, MD, etc.).

Normally, the FUNCTION screen is displayed. If it is not displayed, touch FUNCTION to display it.

Touch FUNCTION in the LCD.

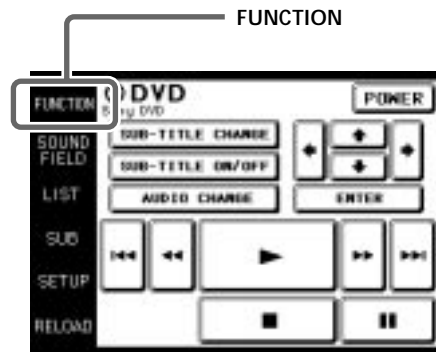

The FUNCTION screen appears.



Composition of the FUNCTION screen is shown on the next page.

 To select a function that is not displayed  
Use the JOG DIAL to scroll.

 You can change the functions displayed in the FUNCTION screen

You can set all functions, except TUNER, REC EDIT and CUSTOMIZE to be displayed or not, using the FUNCTION HOOK UP screen (see page 24).

# Basic Operations

## FUNCTION screen hierarchy

The following diagram shows the composition of the FUNCTION screen hierarchy. The types of icons that can be displayed on the FUNCTION screen can be set using FUNCTION HOOK UP in the SETUP screen. (For details on FUNCTION HOOK UP, see page 24.)

Operation

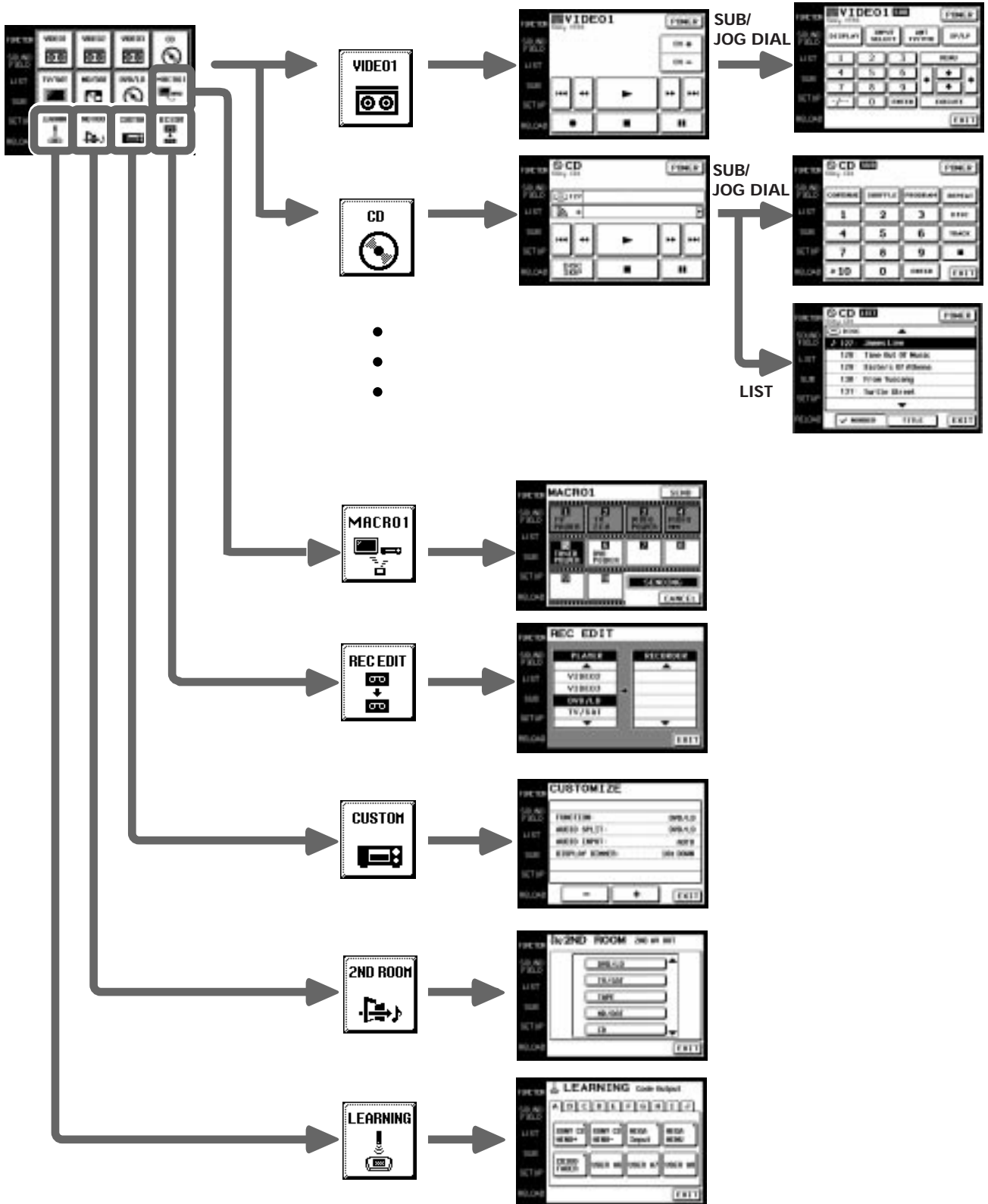

# Example: Operating a CD Player

This section describes how to operate a CD player connected to the receiver. Other components can also be operated in the same way.

For details concerning CD player operation, please refer to your CD player's operating instructions. The screens used in the following example are the screens that appear when using a SONY CD changer with a CONTROL A1/A1II terminal.

## 1 Touch FUNCTION.

The FUNCTION screen appears.

## 2 Touch .

The receiver's function switches to CD and the CD screen appears.

Selected maker and category (see page 23).

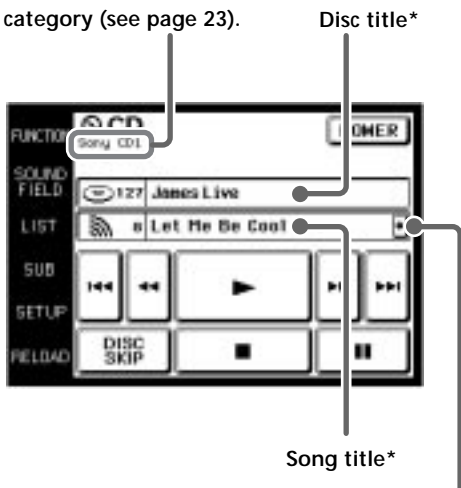

- Long titles can be read by touching the scroll icon () to scroll along the title.

\* Only displayed when a Sony CD changer (5/50/200/300/400 CD) or CD player compatible with CD text is connected to the receiver by a CONTROL A1/A1II cord.

## 3 Touch to start playback.

 When the song number or song title is not displayed correctly

Point the commander toward the receiver and touch RELOAD.

## To operate other functions

Touch SUB or use the JOG DIAL to scroll. Another set of buttons is displayed and ready for use.





## To view the LIST

Touch LIST to view the song titles in a Sony CD changer (5/50/200/300/400 CD) or MD deck connected by a CONTROL A1/A1II cord. In this case, the information must be downloaded from the receiver (see page 24 for details).

The LIST screen can only be displayed when the FUNCTION is set to CD or MD/DAT.



- Touch the disc number to start playing that disc.  appears next to the disc being played.
- Use the JOG DIAL or touch  or  to scroll up or down the list.
- Touch NUMBER to sort in numerical order or touch TITLE to sort in alphabetical order.
- Touch FUNCTION to return to the FUNCTION screen at any time.

# Example: Operating the Tuner

This section describes how to operate the tuner. For details on tuner operation, please refer to the operating instructions provided with the receiver.

## 1 Touch FUNCTION.

The FUNCTION screen appears.

## 2 Touch .

The receiver's function switches to TUNER and the tuner screen appears.

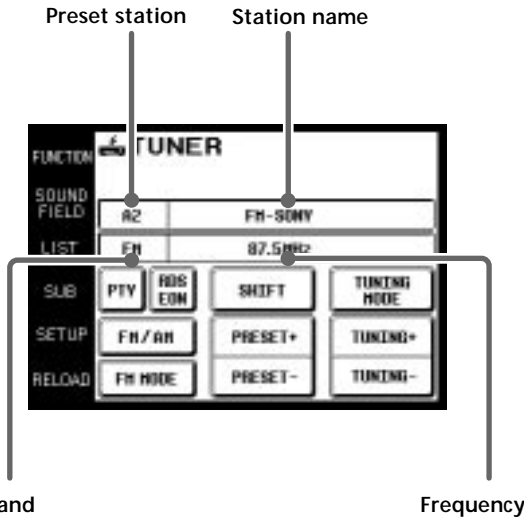

- Touch FM/AM to change the band.
- Touch FM MODE to switch the FM reception mode to AUTO or MONO. If the FM stereo reception is poor, select MONO. You will not be able to enjoy the stereo sound effect, but the sound will be less distorted.
- Touch PRESET + or - to search for preset stations.
- Touch TUNING + or - to search for stations that can be received.
- Touch SHIFT to switch memory pages (A, B, C).
- Touch TUNING MODE to switch the tuning mode to AUTO or MANUAL.<sup>1)</sup>
- During display of any of the screens, touching FUNCTION returns to the FUNCTION screen.
- Touch PTY to specify a program type to scan for stations currently broadcasting the specified program type. Touch PTY repeatedly to select the program type.<sup>2)</sup>
- Touch EON to switch automatically to a station broadcasting T.A. (traffic announcement), NEWS (news), or INFO (information program).<sup>2)</sup>

<sup>1)</sup> Displayed only when the tuner is assigned to another function.

<sup>2)</sup> May not be displayed depending on the model.

 When broadcast stations or frequencies are not displayed properly  
Point the commander at the receiver and touch RELOAD.

## To operate other functions

Touch SUB or use the JOG DIAL to scroll to display the icons used for memorizing broadcast stations.



- To receive manually, touch DIRECT and input the frequency.
- When memorizing a received broadcast station, touch MEMORY and input the preset number.

## Viewing the LIST

Touch LIST to view the names of the broadcast stations downloaded from the receiver (see page 24 for details). The LIST screen can only be displayed when the FUNCTION is set to TUNER.

# Example: Recording from CD to MD

This section describes how to record audio from a CD to an MD as an example of recording audio/video.

### Other operations

Recording from a DVD to a video deck is basically the same procedure. For details on the buttons used in recording, refer to the operating instructions supplied with the receiver and other components.

**1** Touch **FUNCTION**.  
The **FUNCTION** screen appears.

**2** Touch .  
The **REC EDIT** screen appears.

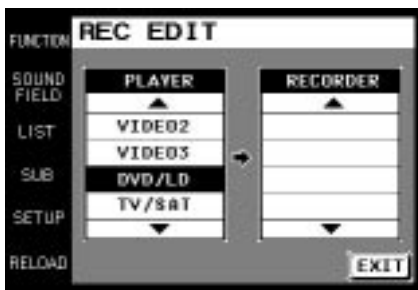

**3** Touch to select the player component (CD in this example).

Because CD is not displayed, use the JOG DIAL or touch ▼ to scroll downward through the list. If you scroll to far, touch ▲ to scroll back up.

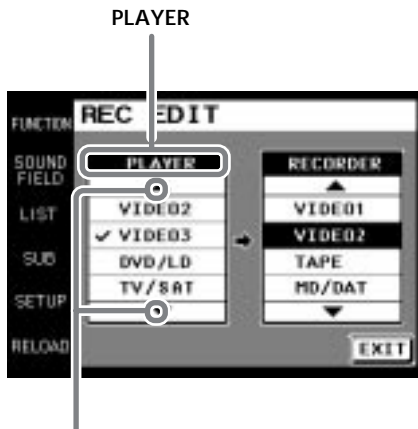

Touching ▲ moves list up  
Touching ▼ moves list down

When **PLAYER** is selected, the receiver's function automatically switches to the **PLAYER** component.

**4** Touch to select the recorder component (MD/DAT in this example).

When MD/DAT is touched, the **REC EDIT** operation screen appears.



**5** Touch ● in **RECORDER: MD/DAT**, then touch ► in **PLAYER: CD**.

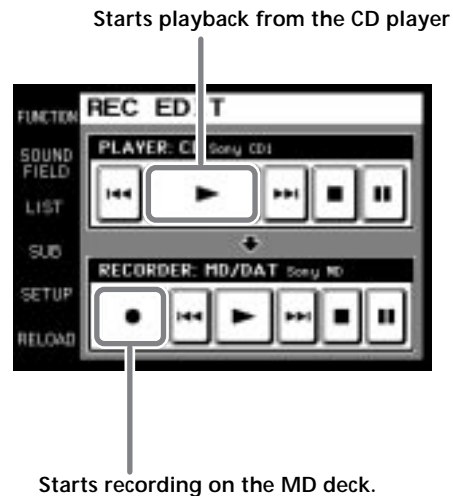

Recording starts.

### To stop recording at any time

Although recording stops automatically in the above example, recording can also be stopped at any time by touching ■ in **RECORDER**.

### To stop the recording procedure at any time

Touch **FUNCTION** to display the **FUNCTION** screen. During steps 2 to 3, touching **EXIT** will also stop the recording procedure.

## Performing Several Commands in Sequence Automatically (Macro Play)

The Macro Play function lets you link several IR codes in sequential order as a single command. The remote provides 3 macro lists (MACRO 1, 2 and 3). You can specify up to 10 IR commands for each macro list.

### 1 Touch FUNCTION.

The FUNCTION screen appears.

### 2 Touch .

The MACRO screen appears.

When  does not appear in the FUNCTION screen, use the JOG DIAL to scroll through the list until it is displayed, and then touch it.

- Touch SEND to operate Macro Play. The current command is displayed in black. The finished commands are grayed out.

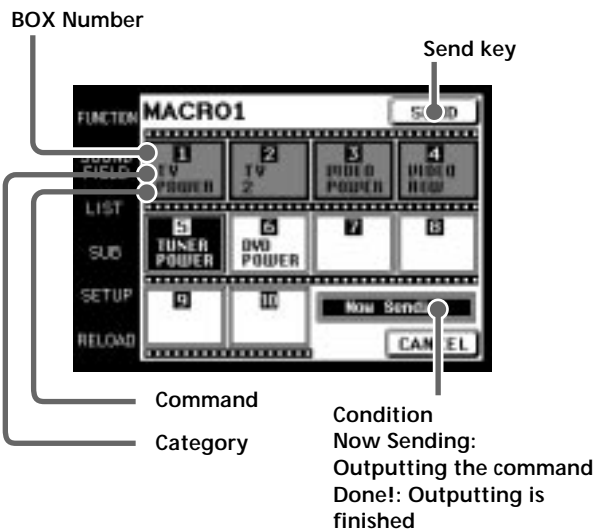

- To cancel Macro Play, touch CANCEL. When Macro Play is not operating, touching CANCEL returns to the FUNCTION screen.

### Notes

- For some models, the receiver cannot operate the Macro Play commands as the time between each command is too short. In this case, set "WAIT TIME" between each command. To set "WAIT TIME", refer to "Macro Play setting" on page 25 and 26.
- For some makers other than Sony, there are some commands that cannot be used in Macro Play.

## Changing receiver settings

You can set the receiver's audio input, or change the brightness of the display.

### 1 Touch FUNCTION.

The FUNCTION screen appears.

### 2 Touch .

The CUSTOMIZE screen appears.

When  does not appear in the FUNCTION screen, use the JOG DIAL to scroll through the list until it is displayed, and then touch it.



- To change the audio input of the function which is not currently selected, touch FUNCTION.
- To change the audio input of the current function, touch AUDIO SPLIT.
- To change the INPUT MODE of the current audio input, touch AUDIO INPUT.
- To adjust the brightness of the display, touch DISPLAY DIMMER.

### 3 Press the button or the button repeatedly until the desired setting appears.



## Using a command that has been learned

By using the Learning function, it is possible for this commander to perform learned operations. For details on how to learn the operation codes of other components using the Learning function, see page 27.

### 1 Touch FUNCTION.

The FUNCTION screen appears.



### 2 Touch

When  does not appear in the screen, use the JOG DIAL to scroll the screen until it is displayed, and then touch it.

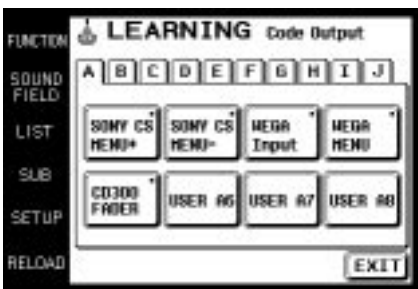

### 3 Touch the appropriate area from A to J corresponding to the learned command.

### 4 Touch the box containing the code you want to send.

A mark (■) appears in the box when it has already learned a command.

## Selecting a source to listen to using 2ND ROOM

Select a source that you would like to enjoy listening to in another room. You can switch the audio output to the 2ND AV OUT on the receiver. For details, please refer to the operating instructions supplied with your receiver.

### 1 Touch FUNCTION.

The FUNCTION screen appears.



### 2 Touch

When  does not appear on the screen, use the JOG DIAL to scroll the screen until it is displayed, and then touch it.

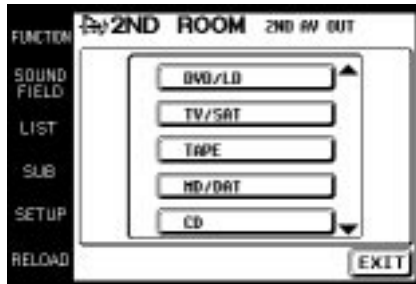

### 3 Touch the source that you want to listen to in another room.

The 2nd AV output on the receiver changes.

# Selecting Sound Fields

These sections describe how to select and make adjustments to the sound fields. For details concerning sound fields, please refer to the operating instructions supplied with the receiver.

## Displaying the SOUND FIELD screen

Touch SOUND FIELD.

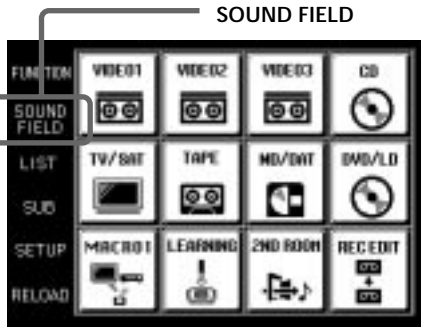

The SOUND FIELD screen appears.



The SOUND FIELD screen hierarchy is shown on the right.

## SOUND FIELD screen hierarchy

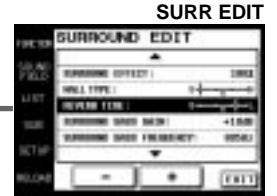
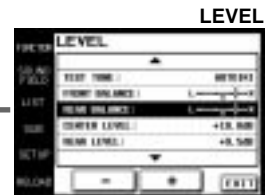
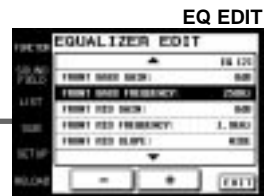
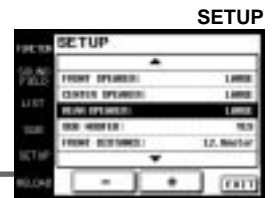
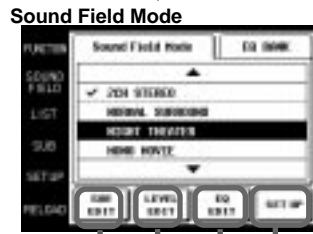
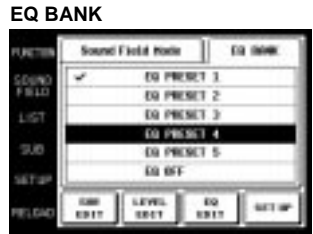

### Selecting the sound field

For details concerning which sound fields can be selected, please refer to the operating instructions supplied with the receiver.

- 1 Touch **SOUND FIELD**.  
The **SOUND FIELD** screen appears.
- 2 Touch **Sound Field Mode**.  
The **Sound Field Mode** screen appears.
- 3 Use the **JOG DIAL** or touch **▲** or **▼** to scroll through the list.
- 4 Push the **JOG DIAL** to select the highlighted sound field or touch the sound field you desire.  
A check (✓) will appear next to the selected sound field, and the sound field will change.

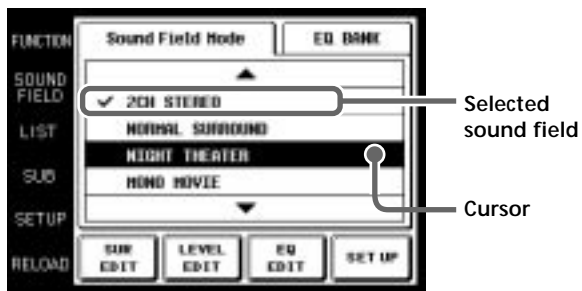

### Selecting the equalizer

- 1 Touch **SOUND FIELD**.  
The **SOUND FIELD** screen appears.
- 2 Touch **EQ BANK**.  
The **EQ BANK** screen appears.
- 3 Touch one of the equalizer presets (**EQ PRESET 1-5**).  
Touch **EQ OFF** to turn the receiver's equalizer off. A check (✓) will appear next to the selected equalizer, and the equalizer settings will change.

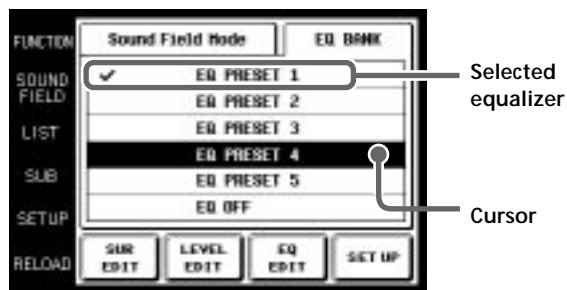

**Note**  
If **EQ OFF** is selected, **EQUALIZER** screen settings cannot be changed.

# Adjusting Sound Fields

Set up the SOUND FIELD screen menus to fully enjoy the surround sound created by the sound fields.

On the EQ EDIT screen, adjust the frequency bands of front, center and rear speakers of the equalizer preset (EQ PRESET 1~5) that you selected on the EQ BANK screen.

Adjust various aspects of individual sound fields on the SURROUND screen. The settings are stored individually for each sound field.

Adjust the output level of each speaker and perform a variety of other adjustments to control the sound mix on the LEVEL screen.

CUSTOM allows you to customize other operations that the receiver performs. For details on what can be adjusted, refer to the operating instructions supplied with the receiver.

Set speaker configuration, size and distance from the main listening position on the SETUP screen.

## Adjusting the frequency bands

- 1 Touch EQ EDIT on the SOUND FIELD screen. The EQUALIZER screen of the equalizer preset selected in the EQ BANK screen appears. If EQ OFF is selected in the EQ BANK screen, EQUALIZER screen items are all grayed out, and edit functions cannot be performed.
- 2 Use the JOG DIAL or touch ▲ or ▼ to scroll through the list.
- 3 Scroll the JOG DIAL to select an item or touch the item you want to adjust.

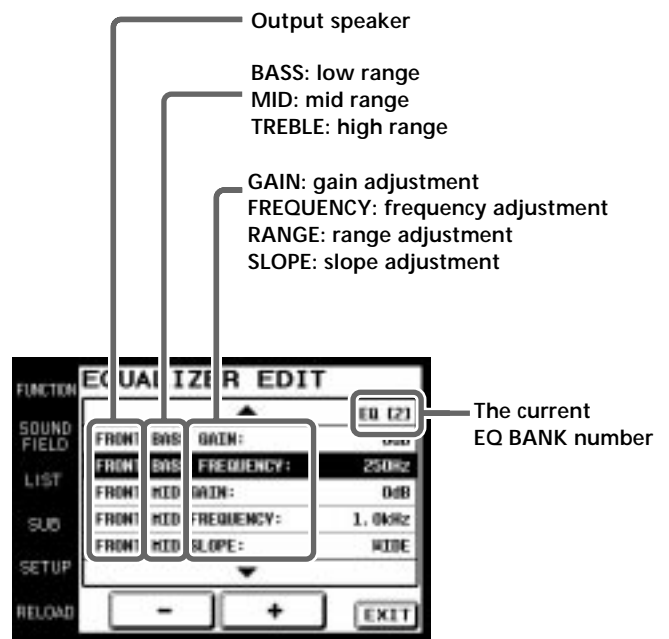

- 4 Touch  or  to adjust to the desired value.
- 5 Repeat steps 2 through 4 when there is more than one item that you wish to adjust.
- 6 Touch EXIT when adjustment is finished.

### Notes

- Items that cannot be adjusted due to the current speaker settings or sound field mode are grayed out.
- If the alarm sounds, or all items appear to be grayed out, touch RELOAD.

### Adjusting the surround parameters

- 1 Touch SURR EDIT on the SOUND FIELD screen. The SURROUND screen appears.



- 2 Use the JOG DIAL or touch ▲ or ▼ to scroll through the list.
- 3 Scroll the JOG DIAL to select an item or touch the aspect you want to adjust.
- 4 Touch  or  to adjust to the desired value.

**SURROUND EFFECT:** Higher values increase the “presence” of the surround effect.

**WALL TYPE:** Use to simulate different sonic environments.

**REVERB TIME:** Use to control the spacing of the early reflections to simulate a larger or smaller room.

**SCREEN DEPTH:** Use to control the extent to which the sound appears to be coming from within the screen.

**VIRTUAL SPEAKERS:** Use to set whether to use the virtual speakers or not.

**Tone quality adjustments:** Use these parameters to adjust the overall sound quality of the selected sound field.

- 5 Repeat steps 2 through 4 when there is more than one aspect that you wish to adjust.
- 6 Touch EXIT when adjustment is finished.

**Notes**

- Items that cannot be adjusted due to the current speaker settings or sound field mode are grayed out.
- If the alarm sounds, or all items appear to be grayed out, touch RELOAD.

### Adjusting the speaker levels

- 1 Touch LEVEL EDIT on the SOUND FIELD screen. The LEVEL screen appears.

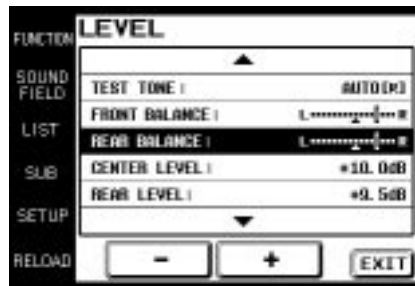

- 2 Use the JOG DIAL or touch ▲ or ▼ to scroll through the list.
- 3 Scroll the JOG DIAL to select an item or touch the item you want to adjust.
- 4 Touch  or  to adjust.
- 5 Repeat steps 2 through 4 when there is more than one item that you wish to adjust.
- 6 Touch EXIT when adjustment is finished.

**To adjust the speaker balance**

Use TEST TONE to listen to the levels output from each speaker. AUTO outputs the test tone to each speaker in order. You can also select individual speakers to output the test tone. Adjust your speaker levels so that the test tone is output at the same level from all speakers.

**Notes**

- Items that cannot be adjusted due to the current speaker settings or sound field mode are grayed out.
- If the alarm sounds, or all items appear to be grayed out, touch RELOAD.

## Adjusting Sound Fields

### Adjusting the speaker settings

- 1 Touch SETUP on the SOUND FIELD screen. The SETUP screen appears.



- 2 Use the JOG DIAL or touch ▲ or ▼ to scroll through the list.
- 3 Scroll JOG DIAL to select a parameter or touch the parameter you want to adjust.
- 4 Touch  or  to adjust to the desired setting.
- 5 Repeat steps 2 through 4 when there is more than one parameter that you wish to adjust.
- 6 Touch EXIT when speaker setup is finished.

#### Notes

- Items that cannot be adjusted due to the current speaker settings or sound field mode are grayed out.
- If the alarm sounds, or all items appear to be grayed out, touch RELOAD.

## Adjusting the Commander's Operating Environment

The following explanations allow you to adjust various settings and customize the commander's operating environment.

### Displaying the SETUP screen

To adjust the operating environment, first display the SETUP screen.

Touch SETUP.

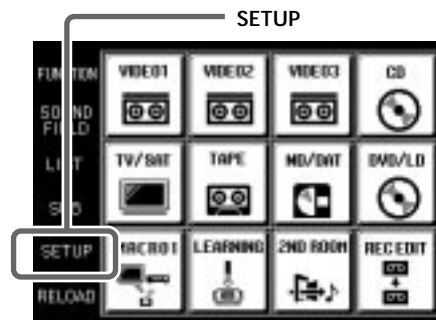

The SETUP screen appears.



## Registering the connected components

The following procedure lets you set up the commander to operate the components connected to the receiver.

When carrying out this operation, make sure that the receiver's power is on, and be sure to point the commander's transmitter/receiver section toward the display on the receiver.

### 1 Touch SETUP.

The SETUP screen appears.

### 2 Touch FUNCTION&USER IR.

The FUNCTION&USER IR screen appears.

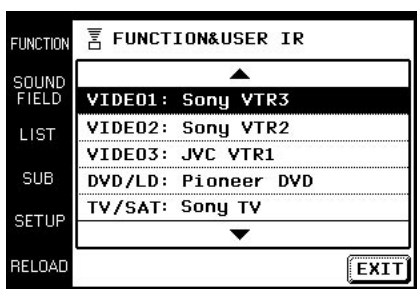

### 3 Select the function that you wish to register (Ex: VIDEO1).

To display other items, use the JOG DIAL or touch ▲ or ▼ to scroll through the list.

The FUNCTION&USER IR:CATEGORY screen appears.

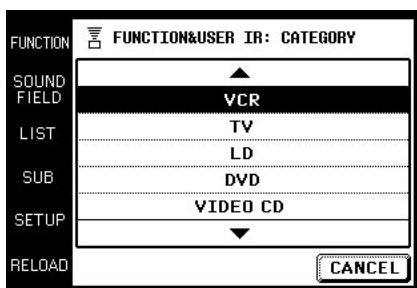

### 4 Select the type of component connected (Ex: VCR).

To display other items, use the JOG DIAL or touch ▲ or ▼ to scroll through the list.

The FUNCTION&USER IR: MAKER CODE screen appears.

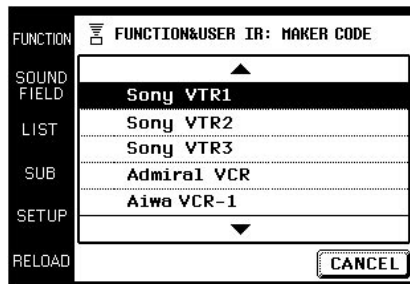

### 5 Touch the remote controller mode of the connected component (Ex: Sony VTR1).

The component selected in steps 4 to 5 will be registered at the function selected in step 3, and the FUNCTION&USER IR screen reappears. A long beep sound is emitted to indicate that registration was successful. Operation is now possible from the FUNCTION screen.

If a series of short beeps is emitted, redo the registration procedure. If this occurs, make sure the receiver is turned on and that the commander is pointing toward the receiver during operation.

To stop registration at any time

Touch EXIT during step 3 or touch CANCEL during steps 4 to 5.

#### Notes

- All icons may not be displayed when registering components made by certain manufacturers.
- Some commands may not function even though they are displayed when registering components made by certain manufacturers.

# Adjusting the Commander's Operating Environment

## FUNCTION screen setup

You can set the FUNCTION screen not to display components you do not use.

- 1 Touch **SETUP**.  
The **SETUP** screen appears.
- 2 Touch **HOOK UP**.  
The **FUNCTION HOOK UP** screen appears.

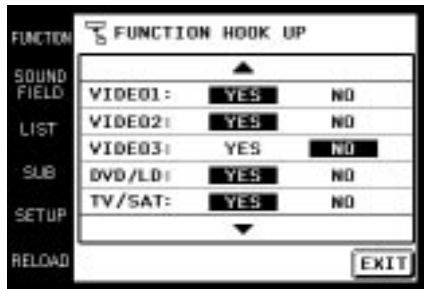

- 3 Select the function not to be displayed and touch **NO**.  
To display other items, use the **JOG DIAL** or touch ▲ or ▼ to scroll through the list.

To display the components set not to be displayed  
Touch **YES** instead of **NO** in step 3.

Components that have been registered are set to "YES" automatically.

**Note**  
When a function does not appear in the display even though **FUNCTION HOOK UP** is set to **YES**, turn the **JOG DIAL** to display the function.

## Downloading receiver data

Various types of data can be downloaded from the receiver.

When carrying out this operation, make sure that the receiver's power is on, and be sure to point the commander's transmitter/receiver section toward the display on the receiver. Also, operate the commander at a distance of about 1-2 meters from the receiver.

- 1 Touch **SETUP**.  
The **SETUP** screen appears.

- 2 Touch **DOWNLOAD**.  
The **DOWNLOAD** screen appears.

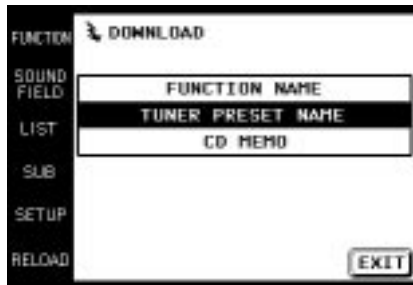

- 3 Touch to select the data you wish to download and press:  
**FUNCTION NAME:** Names of connected components.  
**TUNER PRESET NAME:** Broadcast station names etc., memorized in receiver.  
**CD MEMO:** CD song titles or disc titles etc., from a Sony CD changer (5/50/200/300/400 CD) connected to the receiver with **CONTROL A1/A1II** cord.

Downloading starts, and the progress is displayed. During this time, please leave the commander's transmitter/receiver section pointed toward the display on the receiver.



When you touch **CANCEL**, the data downloaded before you touched **CANCEL** will be saved.

- 4 Repeat step 3 to download other data.
- 5 Touch **EXIT**.  
Downloading finishes and the **SETUP** screen reappears.



## Macro Play setting

The Macro Play function lets you link several IR codes in sequential order as a single command. The following is an example of how to set the command "POWER" for SONY VTR 1 in BOX 2 of MACRO 1. Set other commands in a similar manner.

### 1 Touch SETUP.

The SETUP screen appears.



### 2 Touch MACRO.

The setting screen for Macro Play appears.

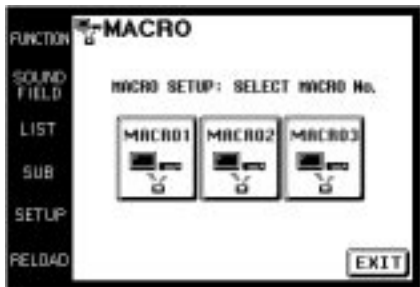

### 3 Select the MACRO Number.

Select MACRO 1, MACRO 2 or MACRO 3 in which you want to register the macro program. For example, select MACRO 1.

The BOX Number list appears.

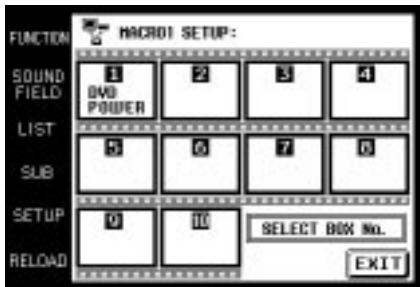

### 4 Select the BOX Number.

Select the BOX Number you want to register the command. You can program up to 10 commands in one area.

The CATEGORY list appears.



### 5 Select the CATEGORY.

Select the component category for the BOX Number you selected in step 4.

The MAKER list appears according to the category you selected.

When the maker is Sony only, go to step 7.

You can select "WAIT TIME" other than audio components as the CATEGORY.

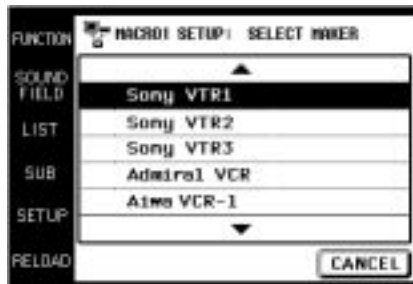

## Adjusting the Commander's Operating Environment

### 6 Select the MAKER.

Select the maker from the maker list.  
The COMMAND list appears according to the maker you selected.

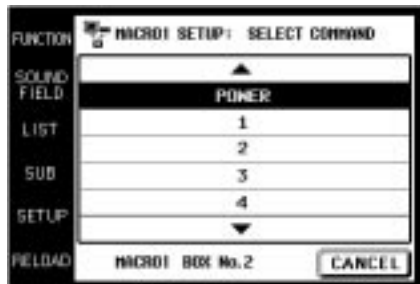

### 7 Select the COMMAND.

Select the command you want to register.  
The items selected in step 5 to 7 are registered in the box selected in step 4.  
The BOX Number list reappears.



To clear the programmed MACRO

Select the BOX Number of the MACRO you want to clear in step 4. Select "MACRO CLEAR" in the CATEGORY in step 5. The items of the BOX are cleared.



To set "WAIT TIME"

Select the BOX Number of the MACRO you want to set the wait time for in step 4. Select "WAIT TIME" in the CATEGORY in step 5.

The wait time list (1 to 10 second in 1 second increments) appears. Select the time you want to delay. After you selected, the BOX Number list reappears.

If you press ALL CLEAR on the SETUP screen, all the registered MACRO programs are cleared.



MACRO 1 has been factory set

MACRO 1 has been factory set to power code of Sony Audio Visual component.

## Setting the function name

### 1 Touch SETUP.

The SETUP screen appears.

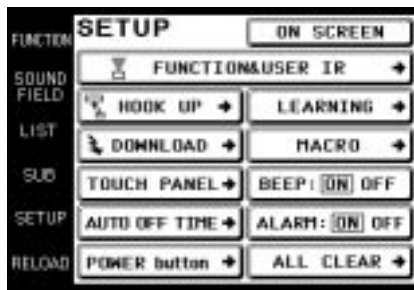

### 2 Touch FUNC NAME.

The FUNCTION NAME EDIT screen appears.  
If FUNC NAME does not appear in the display, use the JOG DIAL to scroll the screen until FUNC NAME appears.

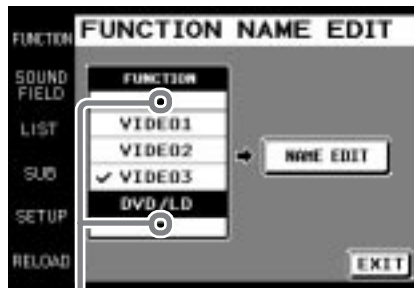

Touching ▲ moves list up  
Touching ▼ moves list down

### 3 Touch the function that you want to edit.

- 4 Touch NAME EDIT.  
The NAME EDIT screen appears.

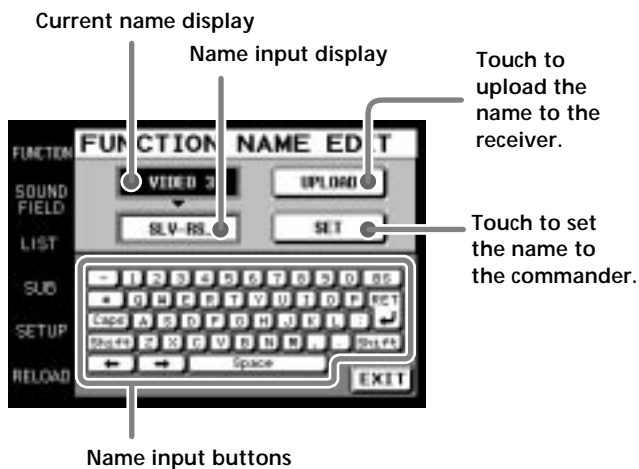

- 5 Enter the name.  
After the name has been entered, touch SET. The new function name is set in the commander.  
After the name has been entered, point the commander toward the receiver and touch UPLOAD. The new function name is set in the receiver.

### Setting remote control codes that are not stored in the commander

When a remote control code is not one of the presets stored in the commander, it is possible for the commander to learn the code using the Learning function. For details on how to use the learned codes, please see page 17.

- 1 Touch SETUP.  
The SETUP screen appears.



- 2 Touch LEARNING.

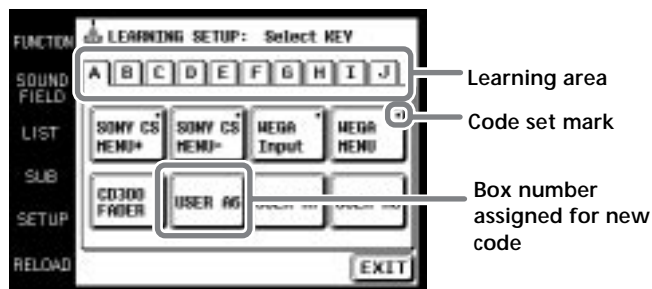

- 3 Touch the area corresponding to where you want the new code to be learned. Any letter from A to J can be selected (for example, select "A").
- 4 Touch the Box Number where you want to save the new code (for example, select "A6").  
The LEARNING SETUP screen is displayed.

Box number assigned for new code

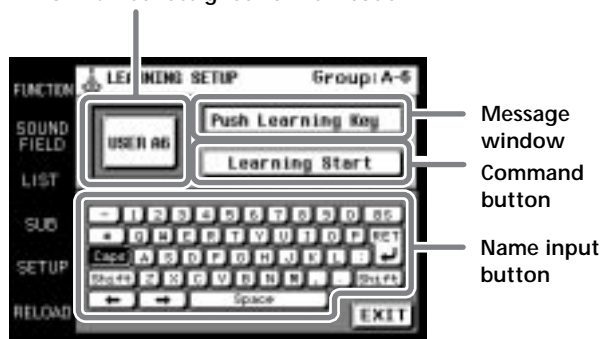

- 5 Touch "Learning Start".  
"Please Send Signal" is displayed.

## Adjusting the Commander's Operating Environment

- 6** Point the remote code receiver section of the commander toward the receiver/transmitter on the remote control to be learned.

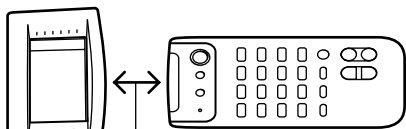

About 5 cm ~ 15 cm

- 7** Press the appropriate button on the remote control to send the remote control code.

Lightly pressing the button once should be sufficient. In about 3 to 5 seconds, it is displayed whether learning was successful or not. When learning is successful, "Learning OK!" is displayed, and a mark (■) will appear next to the selected box.



When learning is not successful, "Learning Fail.." is displayed, and 3 seconds later "Please Send Signal" is displayed again. Please do this procedure again from step 6.

### To erase the learned code

After step 7, touch "Clear" and the display changes to "Clear?". If "Yes" is touched at this time, the newly learned code is erased. If "No" is touched, the code is not erased, and the commander returns to its previous condition.

### 💡 You can test the learned code

Touch "TEST" after "Learning OK" is displayed in step 7. The learned code is sent from the commander, and if correct, the operation corresponding to the learned code is performed.

### 💡 You can make a name of up to 14 characters for the learned code

Touch name input buttons as displayed in step 4 to enter the name.

### Notes

- Normally, in the areas from A to J, there is a total of 80 BOX Numbers that can be used with the Learning function. However, depending on the signals of the codes being learned, it may not be possible for the commander to store codes for all 80 BOX Numbers.
- To learn commands such as volume, fast-forward, rewind (etc.) that are generally performed by continuously pressing the button, press and hold the button until "Learning OK" appears in step 7. For other commands such as play, pause, and stop (etc.) where continuously holding the button is not necessary, learning is usually possible by pressing the button once.
- Some remote control codes cannot be learned.

## Other setup

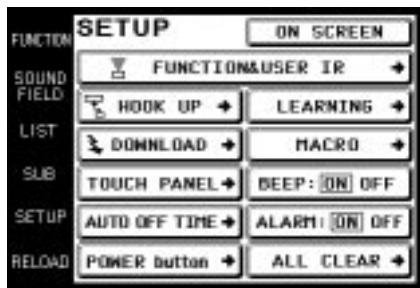

### ■ Display the current settings on the monitor (ON SCREEN)

The receiver's current sound field and SURROUND parameters are displayed on the monitor. Touch ON SCREEN again to return to the SETUP screen.

### ■ Adjusting the position of the touch panel (LCD)

Adjust the position of the LCD when it shifts from the normal operating position.

- 1 Touch TOUCH PANEL on the SETUP screen. The TOUCH PANEL ADJUSTMENT screen appears.
- 2 Touch the center of each of the 4 dots. (For details, see "Touch panel adjustment" on page 6.) "Adjusted" appears in a short while and long beep is emitted.

### ■ Setting the LCD to turn off automatically

The LCD backlight can be set to turn off automatically after operation.

- 1 Touch AUTO OFF TIME on the SETUP screen. The AUTO OFF TIME screen appears.
- 2 Touch + or - or scroll the JOG DIAL to set the desired turn off time. The turn off time can be set between 10 and 30 seconds in 1 second intervals.
- 3 Touch to EXIT.

 To preserve battery life

The turn off time is factory set to 10 seconds. Select a short turn off time in step 2.

### ■ Changing the function of the POWER button

SYSTEM STANDBY: Switches power of all Sony AV components off.

POWER ON/OFF: Switches only the receiver on or off. However, when pressed for more than 3 seconds, the SYSTEM STANDBY code is output.

### ■ Setting the operation beep sound on or off

A beep can be set to sound or not sound when the touch panel is touched.

Touch ON (sound) or OFF (no sound) in BEEP: ON OFF in the SETUP screen.

### ■ Setting the warning alarm on or off

A warning alarm can be set to sound or not sound when a communication error has occurred.

Touch ON (sound) or OFF (no sound) in ALARM: ON OFF in the SETUP screen.

### ■ Returning settings to their factory preset settings

Use this function to erase all memorized settings and return them to their factory presets. Please note that once erased, settings cannot be returned.

When carrying out this operation, make sure that the receiver's power is on, and be sure to point the commander's transmitter/receiver section toward the display on the receiver.

- 1 Touch ALL CLEAR on the SETUP screen.
- 2 Touch YES.

### ■ CONTROL A1/A1II auto function (AUTO FUNC)

ON: When a component connected via a CONTROL A1/A1II cord is played, the power to this unit is turned on and the function selector is automatically set for that component.

OFF: When you do not want linked control of connected components, select [OFF].

When AUTO FUNC does not appear in the display, use the JOG DIAL to scroll the screen until AUTO FUNC appears.

### ■ Setting the AUTO POWER function

**ON:** When a video function (DVD, etc.) is selected, the commander sends numerous codes to the appropriate Sony AV components. You can select the preset input for the TV (VIDEO1 ~ VIDEO4) so that the TV switches to the input after it has been turned on. You can also set the lag time (1 ~ 9 seconds)\* for the input to switch.

**Example)** When you select DVD, the following occurs.

- 1 The receiver switches to DVD player operation mode.
- 2 The TV turns on.
- 3 The DVD player turns on.
- 4 The TV automatically selects the preset input.

**OFF:** When a function is selected, the commander code applies only to receiver operation.

\* Some TVs cannot receive remote control codes immediately after being turned on. In this case, set the lag time according to your TV.

### ■ Setting the initial communication (COMMUNICATION)

Set whether the initial communication (page 6) between the commander and the receiver starts after the commander is turned on.

**ON:** When the commander is turned on, the initial communication starts. Once the initial communication is carried out, the setting automatically switches to OFF.

**OFF:** When the commander is turned on, the initial communication does not start. We recommend setting to OFF when the commander is away from the receiver.

#### Note on initial communication

When you change the initial communication setting from OFF to ON, be sure to leave the commander until it turns off automatically. When you turn on the commander again, the initial communication starts and the commander receives the model information from the receiver (see page 6).

The model information is cleared when the setting is changed from OFF to ON. If the above procedure is not completed, the settings, such as the sound field name, in the commander may differ from those in the receiver.

### ■ Switching the command mode (COMMAND MODE)

When you switch the command mode of the receiver, be sure to also switch the command mode of the commander. When the command mode is correctly set, the transmission is possible between the commander and the receiver.

**COMMAND AV SYSTEM1:** Select when the command mode of the receiver is AV1.

**COMMAND AV SYSTEM2:** Select when the command mode of the receiver is AV2.

# Additional information

---

## Precautions during use

### On installment

Do not drop the commander or subject it to strong vibration as this could cause damage.

### On the touch pen

Use only the touch pen provided with this unit or the soft tip of your finger to operate the touch panel. Using a commercially available writing utensil may damage the panel and make correct operation impossible. If the tip of the touch pen is damaged, or the touch pen is lost, please consult your nearest Sony dealer.

### On battery life

When the backlight is not necessary, do not press BACK LIGHT/COMMANDER OFF to turn on the LCD. Touch the touch panel to turn on just the LCD. The life of the battery will be prolonged. The life of the battery may be shortened depending on the conditions in which the commander is used.

### On handling

The touch panel (display section) is made of glass. Twisting the touch panel, dropping the unit, placing your elbow (etc.) on it, or placing heavy objects on top of it, may break the touch panel and cause bodily harm due to glass fragments.

### On cleaning

Clean the cabinet, panel and controls with a soft cloth slightly moistened with a mild detergent solution. Do not use solvent such as thinner, benzine, or alcohol as these will damage the surface of the commander.

# Troubleshooting

If you experience any of the following difficulties while using the commander, use this troubleshooting guide to help you remedy the problem. Should any problem persist, consult your nearest Sony dealer.

## Operation can not be done with the commander.

- ➔ Check that the receiver and components are connected correctly.
- ➔ The commander and receiver are too far apart.
- ➔ Make sure that there are no objects between the commander and receiver.
- ➔ Make sure that the receiver's power is turned on.
- ➔ The commander's transmitter/receiver section is not pointed at the receiver.
- ➔ The commander's batteries are exhausted. Replace with new alkaline batteries (see page 7).
- ➔ There is an inverter system fluorescent light near the commander or receiver. Please place away from the fluorescent light.
- ➔ Make sure you have selected the correct function on the remote.
- ➔ When you operate a programmed non-Sony component, the remote may not function properly depending on the make and model of the component.

## The receiver's functions and modes do not correlate with the displays on the commander.

- ➔ Initial communication setup has not been done. Use after first carrying out initial communication setup (see page 6).
- ➔ The commander was not pointed at the receiver when it was turned ON. Touch RELOAD, and download component data (see page 8).
- ➔ Select the correct function using the commander.

## LCD does not appear.

- ➔ The LCD is not turned on. Touch the touch panel.
- ➔ Contrast is too light or too dark. Use the CONTRAST control to adjust the contrast of the LCD (see page 6).

## When a CD player, tape deck, or MD deck is connected to the receiver via CONTROL A1/A1II jacks, Auto Function does not work properly.

- ➔ Reprogram the remote (see page 29).

## The SOUND FIELD function does not work.

- ➔ If the receiver has 5.1 INPUT jacks, the SOUND FIELD function becomes inoperable when 5.1CH is selected.

## Commands of components made by manufacturers other than Sony do not function.

- ➔ When registering components made by certain manufacturers, some commands may not function even though they are displayed.

## "5.1INPUT" cannot be selected from the function screen even though the receiver has the 5.1 INPUT jacks.

- ➔ A communication error has occurred. Point the remote towards the receiver and select "5.1INPUT" from the function screen again.

## The remote and the receiver cannot communicate.

- ➔ If the receiver's COMMAND MODE and the remote's COMMAND MODE do not match, transmission is not possible between the remote and the receiver.



---

## Specifications

### Operating system

Liquid crystal touch panel

### Liquid crystal size

3.8 inches  
(256 x 200 dots)

### Liquid crystal type

Reflection system  
(Monochrome type)

### Touch panel

Resistant membrane system  
Analog type

### Power requirements

For operation:  
DC 6V  
(Type AA alkaline batteries),  
DC IN 6V  
jack accepts  
(300 mA minimum)

For memory preservation:  
DC 3V  
(CR2032 lithium battery)

Maximum external dimensions  
(width x height x depth, including projecting parts and controls)

160 x 111 x 46 mm

### Mass

290 g (Main unit only including touch pen)

Design and specifications are subject to change without notice.

---

## Index

### A

AC power adapter 5

### B

Battery 5, 7

### C

CD player 13

### D, E

Downloading receiver data 24

### F, G, H, I, J, K, L

Front panel 9

FUNCTION Screen 11, 12  
setup 24

### M, N

Macro Play 16, 25, 26

### O, P, Q

Operating components  
CD player 13  
Recording 15  
Tuner 14

### R

Rear panel 10  
Recording 15  
Registering the connected component 23

### S

Setup  
commander 6  
environment 22~30  
FUNCTION screen 24  
SETUP screen 23  
SOUND FIELD 18~19

### T, U, V, W, X, Y, Z

Tuner 14





